

Linear

MOMO-F R207

Fixture Guide

KKDÖ



Indoor /Outdoor | Recessed | Output up to 1269lm/m (387lm/ft)



Key applications

- ✓ Bathrooms
- ✓ Pathways/driveways
- ✓ Building facades
- ✓ Special effect
- ✓ Direct lighting
- ✓ Uplighting
- ✓ Exterior
- ✓ Wall grazing
- ✓ In ground
- ✓ Wallwashing
- ✓ Interior
- ✓ Wet area
- ✓ Orientation lighting

Key features

- ✓ Asymmetric lens
- ✓ Glare control options
- ✓ Custom lengths
- ✓ In ground walkover
- ✓ Constant Voltage (CV)
- ✓ IP67 waterproof
- ✓ Diffusion: homogenous
- ✓ LEDmix dynamic white
- ✓ Direct view
- ✓ Lens options
- ✓ Extensive CCT range

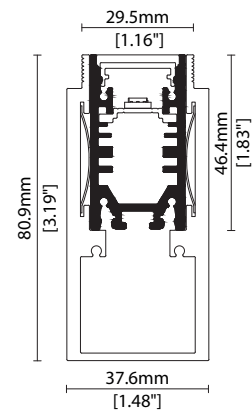

MOUNTING METHODS



KKFR-03 Ground box



KKCP-11 Concealed clip

Warm-dim

Output Luminance %

min DIM1 Input Level max

— CH1 (Warmer)
— CH2 (Cooler)

LEDmix R207

CCT Selection 1 CCT Selection 2

LEDmix R209

CCT Selection 1 CCT Selection 2

LEDmix **warm dim** (Dynamic white) is a pre-programmed dimming curve setting enabling two different colour temperatures (CCTs) to blend harmoniously to achieve a warming lighting effect when dimmed.

KKDC LEDmix strips allow two separate CCT selections to be specified within the same PCB strip.

Use the table opposite to help determine which 2 CCT selections you require according to your preferred cool to warm dimming range.

**Note: The blended CCT is approx. 'cool-end' result at 100% brightness based on using the KKDC LED CCT specification.*

CCT Selection 1	CCT Selection 2	
	Blended CCT*	PCB CCT
1900K~	2000K 2100K 2200K 2300K 2500K 2600K 2700K 3000K 3500K	2100K PCB 2300K PCB 2500K PCB 2700K PCB 3000K PCB 3200K PCB 3500K PCB 4000K PCB 5000K PCB
2100K~	2200K 2300K 2400K 2600K 2700K 2800K 3000K 3600K	2300K PCB 2500K PCB 2700K PCB 3000K PCB 3200K PCB 3500K PCB 4000K PCB 5000K PCB
2300K~	2400K 2500K 2700K 2800K 2900K 3100K 3700K	2500K PCB 2700K PCB 3000K PCB 3200K PCB 3500K PCB 4000K PCB 5000K PCB
2500K~	2600K 2800K 2800K 3000K 3200K 3800K	2700K PCB 3000K PCB 3200K PCB 3500K PCB 4000K PCB 5000K PCB
2700K~	2900K 3000K 3100K 3400K 3900K	3000K PCB 3200K PCB 3500K PCB 4000K PCB 5000K PCB
3000K~	3100K 3300K 3500K 4000K	3200K PCB 3500K PCB 4000K PCB 5000K PCB
3200K~	3300K 3600K 4100K	3500K PCB 4000K PCB 5000K PCB
3500K~	3700K 4300K	4000K PCB 5000K PCB
4000K~	5100K	5000K PCB

Tuneable white

Channel Mix Ratio %

min DIM1 Input Level max

— CH1 (Warmer)
— CH2 (Cooler)

LEDmix R207

CCT Selection 1 CCT Selection 2

LEDmix R209

CCT Selection 1 CCT Selection 2

LEDmix **tunable white** enables two different LED colour temperatures (CCTs) to be specified within the same LEDmix strip.

Each CCT selection can then be independently controlled (via your dimming control system) to adjust the warm & cool light output (CCT selections) and thus tailor a blended light colour of your choosing.

CCT Selection 1	CCT Selection 2
1900K~	2100K 2300K 2500K 2700K 3000K 3200K 3500K 4000K 5000K
2100K~	2300K 2500K 2700K 3000K 3200K 3500K 4000K 5000K
2300K~	2500K 2700K 3000K 3200K 3500K 4000K 5000K
2500K~	2700K 3000K 3200K 3500K 4000K 5000K
2700K~	3000K 3200K 3500K 4000K 5000K
3000K~	3200K 3500K 4000K 5000K
3200K~	3500K 4000K 5000K
3500K~	4000K 5000K
4000K~	5000K

Linear

MOMO-F R207

Specification sheet



Dimensions	H46.4/W25/L103-2020mm* (H1.83/W0.98/L4.05-79.52in*) *KKLN-A2 = 1020mm/40.16in max
PCB Cut-point	83.3mm increment/2000mm max* (3.28in increment/78.74in max*) *KKLN-A2 = 1000mm/39.37in max
LED Pitch	13.9mm-144LED/m (0.55in - 44LED/ft)
Chip	s-line k-line
Cover/Optics	Clear (100°)/Clear + Micro louvre/Clear + KKLN-01 lens (18°)/Clear + KKLN-01 lens (18°) + Micro louvre/Clear + KKLN-03 lens (23°)/Clear + KKLN-03 lens (23°) + Micro louvre/Clear + KKLN-A2 Asymmetric lens (Beam tilt 15°, Beam angle 45°)/Diffused (95°)
CCT	s-line: 1900K/2100K/2300K/2500K/2700K/3000K/3500K/4000K/5000K k-line: 1900K/2100K/2300K/2500K/2700K/3000K/3500K/4000K/5000K
LED binning	s-line: 2.5-step MacAdam ellipse k-line: 3-step MacAdam ellipse
CRI	≥94
Lifetime	50,000 hours @ 25°C (50,000 hours @ 77°F)
Operating temp	T _a = -25 to 50°C (T _c max = 78.9°C) T _a = -13 to 122°F (T _c max = 174°F)
IP Rating	IP67
Finish	Silver anodised
Mounting	Ground recessed or surface mounted via concealed clips
Power feed	Sheathed hardwire tails or male/female connectors
Control	0-10V/1-10V/DMX/DALI



LED Grading Key

Exclusive Grade

s-line* *KKDC tuned
2-step CCT range CCT range

Base Grade

k-line
3-step commercial range
Energy Star CCTs

Power consumption	Supply voltage	Supply current
16W/m (4.88W/ft)	24V DC	0.67A/m (0.20A/ft)

Performance Data (2100K+5000K)

	R1	R2	R3	R4	R5	R6	R7	R8	R9	R10	R11	R12	R13	R14
k-line	95	94	95	97	95	90	92	94	93	91	97	76	94	99
	Clear	Clear + Micro Louvre	Clear + KKLN-01 (18°)	Clear + KKLN-01 (18°) + Micro Louvre	Clear + KKLN-03 (23°)	Clear + KKLN-03 (23°) + Micro Louvre	Clear + KKLN-A2 Asymmetric lens	Diffused Cover	CRI	R9	Rf	Rg		
s-line	1269lm/m (387lm/ft) 79.3lm/W	372lm/m (113lm/ft) 23.3lm/w	719lm/m (219lm/ft) 44.9lm/W	336lm/m (102lm/ft) 21lm/W	790lm/m (241lm/ft) 49.4lm/W	400lm/m (122lm/ft) 25.0lm/W	1241lm/m (378lm/ft) 77.6lm/W	602lm/m (184lm/ft) 37.6lm/W	96	94	-	-		
k-line	1197lm/m (365lm/ft) 74.8lm/W	351lm/m (107lm/ft) 21.9lm/w	678lm/m (207lm/ft) 42.4lm/W	320lm/m (98lm/ft) 20lm/W	746lm/m (227lm/ft) 46.6lm/W	378lm/m (115lm/ft) 23.6lm/W	1171lm/m (357lm/ft) 73.2lm/W	568lm/m (173lm/ft) 35.5lm/W	95	93	-	-		

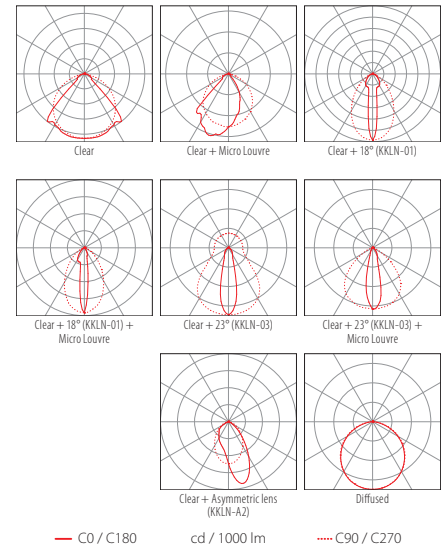
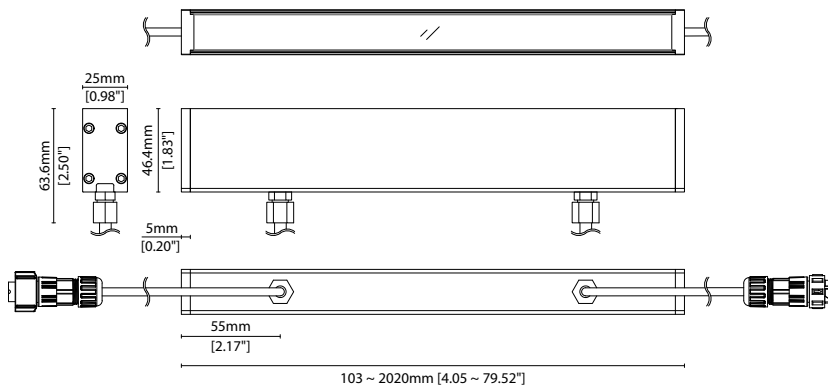

Data derived from independent UKAS/IESNA LM-79-08 accredited testing of production samples.

MOMO-F R207

Code Table



FIXTURE

Model	Finish	Cover/Lens ¹	Grade ²	LED	Colour (CCT)	Length Availability ³	IP	Cable Length	Power Feed ⁴	Input											
MOMO-F	MF	Silver Anodised	SA	Clear	B	s	R207	R207	1900K	19	m	103-2020mm 83.3mm increments	IP67 ⁵	67	300mm/11.81in	0300	Single ø6.3mm sheath tail	S00B	DC 24V	g	
				Clear + Micro Louvre	K	k			2100K	21							Double ø6.3mm sheath tail	D00B			
				Clear + 18° (KKLN-01)	P				2300K	23	i	4.05-79.53in 3.28in increments									
				Clear + 18° (KKLN-01) + Micro Louvre	U				2500K	25		(Specify length code OR total run length)					Single ø6.3mm sheath IP67 connector	S67B			
				Clear + 23° (KKLN-03)	A				2700K	27							Double ø6.3mm sheath IP67 connector	D67B			
				Clear + 23° (KKLN-03) + Micro Louvre	AK				3000K	30											
				Clear + KKLN-A2 Asymmetric lens	BA2				3500K	35											
				Diffused	C				4000K	40											
									5000K	50											

¹ Refer to **Cover/Lens Options** on **Options** pages ² Refer to **LED Grading Key** on **Specification sheet** page ³ Refer to **Length Availability List** or enter total run length instead of length code

⁴ Refer to **Power Feed Options** on **Options** pages ⁵ LEDmix requires two colour temperature choices

⁶ Due to the clear, flush potted polyurethane top layer on IP67 MOMO-F a colour shift of +/-20K should be expected

Code Example:

MF	-	SA	-	C	-	s	-	R207	-	2150	-	m	520	-	67	-	0300	-	D67B	-	g
MOMO-F		Silver Anodised		Diffused		s		R207		2100K+5000K		520mm		IP67		300mm/11.81"		Double ø6.3mm sheath IP67 connector		DC 24V	

ACCESSORIES

Mounting Accessories

KKFR-03	Ground box
KKCP-11	Concealed clip

* Refer to **Mounting accessories** on **Accessories** pages

Connection Accessories

CN67-4P-0300	IP67 4 PIN LEDmix male & female 300mm/11.81" pair
CN67-4P-1000	IP67 4 PIN LEDmix male & female 1000mm/39.37" pair
CN67-4P-3000	IP67 4 PIN LEDmix male & female 3000mm/118.11" pair

* Refer to **Power feed** on **Accessories** pages

Exterior Junction Boxes

KKJB-07	IP67 Slim J-Box
KKJB-07R	Potting Resin for IP67 Slim J-Box

* Refer to **Exterior Junction Boxes** on **Accessories** pages

PSU/Driver

0-10V/1-10V/DALI/DMX

* Refer to **Driver/PSU Options** page for details or provide requirement and KKDC to offer the suitable option

LED Engine Variants (LED Strip Type)

Colour	LED	Lumen/m	Lumen/ft	W/m	W/ft	Spec Doc	Length	Increment
Single CCT	R007	556	169	7	2.13	MOMO-F R007	103-2020mm (4.05-79.52in)	41.7mm (1.64in)
	R014	1137	346	14	4.27	MOMO-F R014	103-2020mm (4.05-79.52in)	41.7mm (1.64in)
	R020	1548	472	20	6.10	MOMO-F R020	103-2020mm (4.05-79.52in)	41.7mm (1.64in)
	R030	2280	695	30	9.14	MOMO-F R030	103-2020mm (4.05-79.52in)	41.7mm (1.64in)
	A040	3656	1114	40	12.19	MOMO-F A040	97-1520mm (3.82-59.84in)	38.46mm (1.51in)
Warm Dim/Dynamic White	R207	1269	387	16	4.88	MOMO-F R207	103-2020mm (4.05-79.52in)	83.3mm (3.28in)
RGB	501	Red: 124 Green: 265 Blue: 41 RGB: 382	Red: 38 Green: 81 Blue: 13 RGB: 116	15.6	4.75	MOMO-F RGB	103-2020mm (4.05-79.52in)	83.3mm (3.28in)
RGBW	R201	971	296	20	6.10	MOMO-F RGBW	155-2030mm (6.10-79.92in)	62.5mm (2.46in)

* Performance data: s-line, 2100K + 5000K, clear cover

MOMO-F R207

Length Availability List

Length Code		Fixture Length ¹		LED Strip ²		End Cap Dimension ³		Wattage (W)	Output (lm)
Metric	Imperial(US)	Metric	Imperial(US)	Metric	Imperial(US)	Metric	Imperial(US)		3000K (Test Data)
m0103	i0004	103mm	4.07in	83mm	3.28in	10mm	0.39in	2.50	179
m0187	i0007	187mm	7.35in	167mm	6.56in	10mm	0.39in	5.00	359
m0270	i0011	270mm	10.63in	250mm	9.84in	10mm	0.39in	7.50	538
m0353	i0014	353mm	13.91in	333mm	13.12in	10mm	0.39in	10.00	717
m0437	i0017	437mm	17.19in	417mm	16.40in	10mm	0.39in	12.50	896
m0520	i0020	520mm	20.47in	500mm	19.69in	10mm	0.39in	15.00	1076
m0603	i0024	603mm	23.75in	583mm	22.97in	10mm	0.39in	17.50	1255
m0687	i0027	687mm	27.03in	667mm	26.25in	10mm	0.39in	20.00	1434
m0770	i0030	770mm	30.31in	750mm	29.53in	10mm	0.39in	22.50	1613
m0853	i0034	853mm	33.60in	833mm	32.81in	10mm	0.39in	25.00	1793
m0937	i0037	937mm	36.88in	917mm	36.09in	10mm	0.39in	27.50	1972
m1020	i0040	1020mm	40.16in	1000mm	39.37in	10mm	0.39in	30.00	2151
m1103	i0043	1103mm	43.44in	1083mm	42.65in	10mm	0.39in	32.50	2330
m1187	i0047	1187mm	46.72in	1167mm	45.93in	10mm	0.39in	35.00	2510
m1270	i0050	1270mm	50.00in	1250mm	49.21in	10mm	0.39in	37.50	2689
m1353	i0053	1353mm	53.28in	1333mm	52.49in	10mm	0.39in	40.00	2868
m1437	i0057	1437mm	56.56in	1417mm	55.77in	10mm	0.39in	42.50	3047
m1520	i0060	1520mm	59.84in	1500mm	59.06in	10mm	0.39in	45.00	3226
m1603	i0063	1603mm	63.12in	1583mm	62.34in	10mm	0.39in	47.50	3406
m1687	i0066	1687mm	66.40in	1667mm	65.62in	10mm	0.39in	50.00	3585
m1770	i0070	1770mm	69.69in	1750mm	68.90in	10mm	0.39in	52.50	3764
m1853	i0073	1853mm	72.97in	1833mm	72.18in	10mm	0.39in	55.00	3943
m1937	i0076	1937mm	76.25in	1917mm	75.46in	10mm	0.39in	30.00	2151
m2020	i0080	2020mm	79.53in	2000mm	78.74in	10mm	0.39in	60.00	4302

¹ Actual total overall length of light fixture (LED strip + end caps + void/wire hole)

² Actual length of PCB strip

³ Actual length of 2x end caps

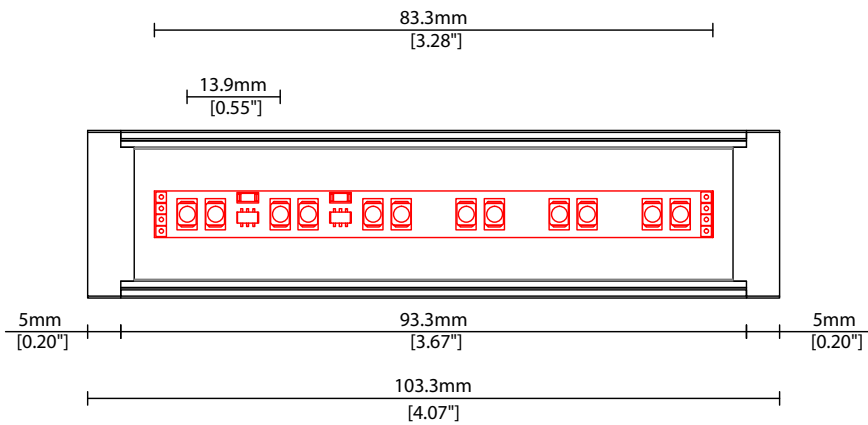

COVER/LENS OPTIONS

* Options are an integral part of the fixture ordering codes. Please refer to **Code Table** pages.

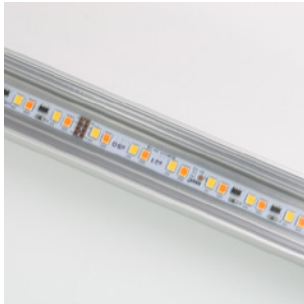

B Clear Cover
W25.0/H46.4mm (W0.98/H1.83")

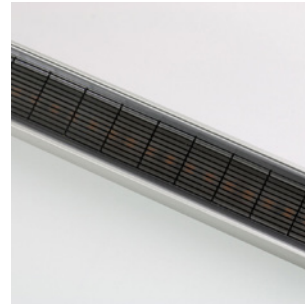
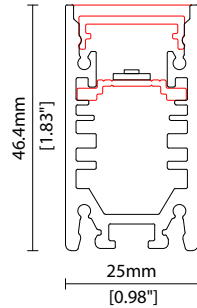

K Clear Cover + Micro louvre
W25.0/H46.4mm (W0.98/H1.83")

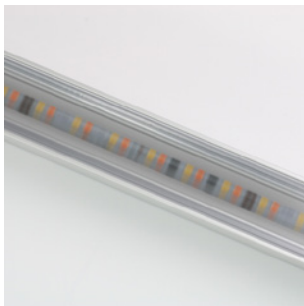
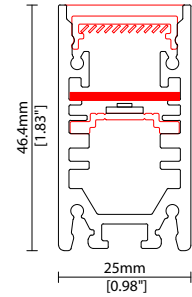

P Clear Cover KKLN-01 (18°)
W25.0/H46.4mm (W0.98/H1.83")

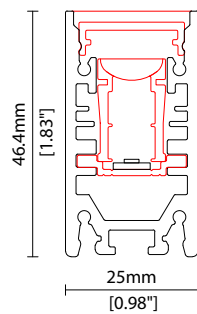

U Clear Cover + KKLN-01 (18°)
+ Micro louvre
W25.0/H46.4mm (W0.98/H1.83")

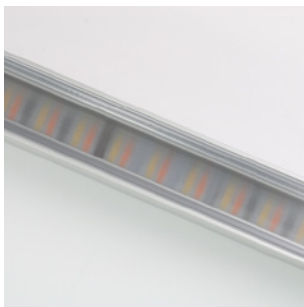
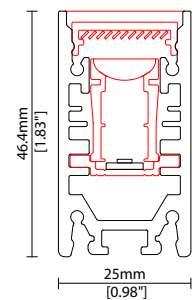

A Clear Cover + KKLN-03 (23°)
W25.0/H46.4mm (W0.98/H1.83")

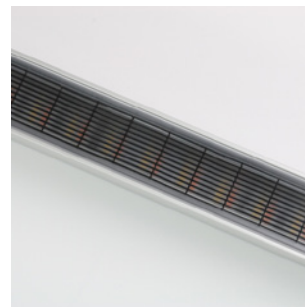
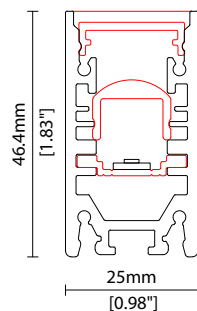

AK Clear Cover +
KKLN-03 (23°) + Micro louvre
W25.0/H46.4mm (W0.98/H1.83")

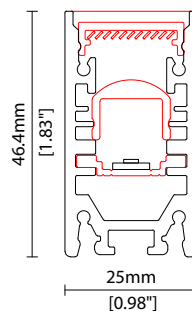

Linear

MOMO-F R207

Options

KKDC

COVER/LENS OPTIONS



BA2 Clear Cover + KKLN-A2
Asymmetric lens
W25.0/H46.4mm (W0.98/H1.83")

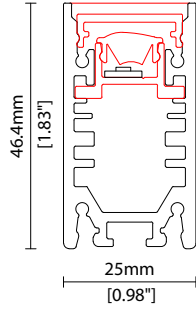

C Diffused Cover
W25.0/H46.4mm (W0.98/H1.83")

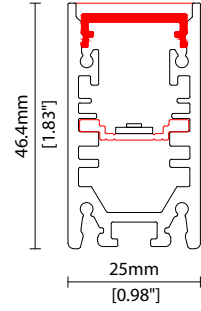

POWER FEED OPTIONS

0300 S00B 300mm (11.81") Single Ø6.3mm sheath tail

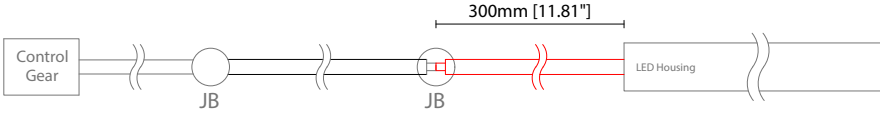

0300 D00B 300mm (11.81") Double Ø6.3mm sheath tail

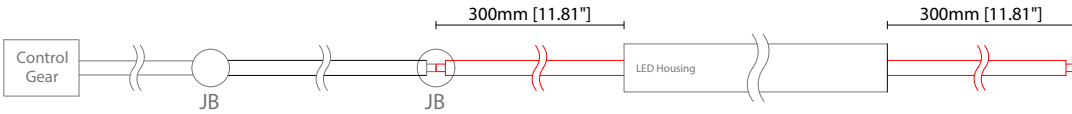

0300 S67B 300mm (11.81") Single Ø6.3mm sheath IP67 connector (Premoulded)

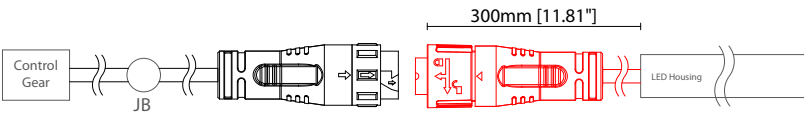

0300 D67B 300mm (11.81") Double Ø6.3mm sheath IP67 connector (Premoulded)

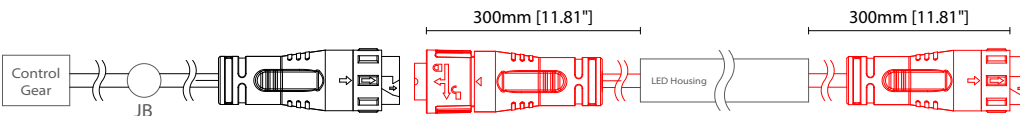

4 Pin LEDmix Female Connector IP67 (Premoulded)

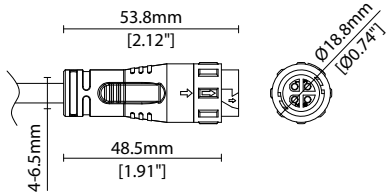

4 Pin LEDmix Male Connector IP67 (Premoulded)

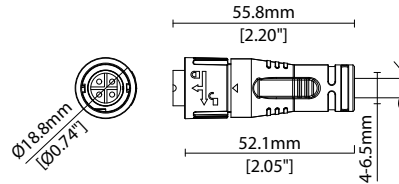

Key

- Control Gear Power supply, sub-controllers & control systems
- JB Junction box / cable connection

MOUNTING ACCESSORIES

Note: Accessories are to be ordered separately with corresponding code shown below.



KKFR-03*
Ground box
Anodised aluminium finish
W37.6/H80.9mm (W1.48/H3.19")
* Specify length to match MOMO-F

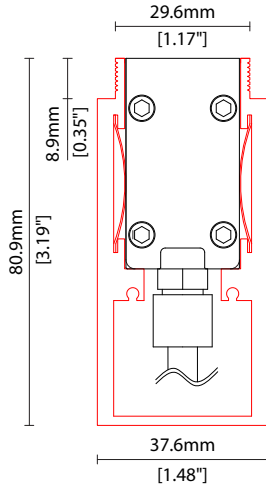

KKCP-11
Concealed clip
(allow 3 per metre/40in)
S/Steel finish
L20/W22/H28.1mm
(L0.79/W0.87/H1.11")

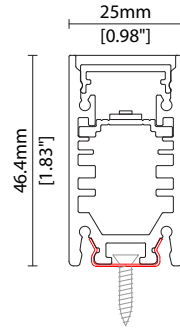

POWER FEED



CN67-4P-0300 300mm (11.81in) pair
CN67-4P-1000 1000mm (39.37in) pair
IP67
4 PIN male + female (RGB/LEDmix) connector set

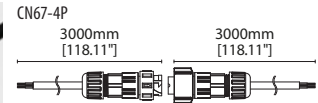

CN67-4P-3000 3000mm (118.11in) pair
IP67
4 PIN male + female (RGB/LEDmix) connector set

EXTERIOR JUNCTION BOXES



KKJB-07
IP67 Slim J-Box
(including type A,B,C, D bushings)



KKJB-07R
Potting resin for IP67 Slim J-Box

KKDC CONTROL



IP20
Plastic housing
L170/W59/H29mm
(L6.69/W2.32/H1.14in)

KKDM-06 1-10V

visDIM dimmable sub-controller
(4 x 8A max @ 12-36V)



IP20
Plastic housing
L170/W53.4/H28mm
(L6.69/W2.10/H1.10in)

KKSC-05 DMX

visDIM dimmable sub-controller
(4 x 5A max @ 12-36V)



IP20
Plastic housing
L170/W59/H29mm
(L6.69/W2.32/H1.14in)

KKDL-02 DALI

visDIM dimmable sub-controller
(4 x 8A max @ 12-36V)



IP20
Plastic housing
L166/W53.4/H23mm
(L6.54/W2.10/H0.91in)

KKDL-03 DALI

visDIM dimmable sub-controller
(4 x 5A max @ 12-36V)



IP20
Plastic housing
L170/W53.4/H28mm
(L6.69/W2.10/H1.10in)

KKDL-04 DALI-2

visDIM dimmable sub-controller
(4 x 5A max @ 12-36V)

AVAILABLE PSU OPTIONS

Control Mode	PSU (Order Code)	Input Voltage AC	Output Voltage DC	Rated Output Current	Rated Power	Dim %	IP Rating
Switched	CEN-60-24	90-295V	24V	2.5A	60W	-	IP67
	HLG-60H-24	90-305V	24V	2.5A	60W	-	IP67
	HLG-100H-24	90-305V	24V	4.0A	100W	-	IP67
	HLG-150H-24	90-305V	24V	6.3A	150W	-	IP67
	HLG-240H-24	90-305V	24V	10A	240W	-	IP67
0-10V (1-10V)	PWM-40-24	90-305V	24V	1.67A	40W	100-0.15 (100-10)	IP67
	PWM-60-24	90-305V	24V	2.5A	60W	100-0.15 (100-10)	IP67
	PWM-90-24	90-305V	24V	3.67A	90W	100-0.15 (100-10)	IP67
	PWM-120-24	90-305V	24V	5.0A	120W	100-0.15 (100-10)	IP67
DALI	LIN100A1	120-277V	24V	1A per channel	100W	100-0.1	IP66/IP40
DMX RGB	LIN100A1	120-277V	24V	1.33A per channel	100W	100-0.1	IP66/IP40
DMX RGBW	LIN100A1	120-277A	24V	1A per channel	100W	100-0.1	IP66/IP40

Flicker Free Options - Combination of PSU+ sub-controller

Control Mode	PSU (Order Code)	Sub-controller (Order Code)	Input Voltage AC	Output Voltage DC	Rated Output Current	Rated Power	Dim %	IP Rating PSU/ Sub-controller
0-10V or 1-10V	CEN-60-24	KKDM-06	90-295V	24V	2.5A	60W	100-0.9	IP67/IP20
	HLG-60H-24	KKDM-06	90-295V	24V	2.5A	60W	100-0.9	IP67/IP20
	HLG-100H-24	KKDM-06	90-295V	24V	4.0A	100W	100-0.9	IP67/IP20
	HLG-150H-24	KKDM-06	90-295V	24V	6.3A	150W	100-0.9	IP67/IP20
	HLG-240H-24	KKDM-06	90-295V	24V	10.0A	240W	100-0.9	IP67/IP20
DALI	CEN-60-24	KKDL-02/03/04/visDIM PRO 30	90-295V	24V	2.5A	60W	100-0.1	IP67/IP20
	HLG-60H-24	KKDL-02/03/04/visDIM PRO 30	90-305V	24V	2.5A	60W	100-0.1	IP67/IP20
	HLG-100H-24	KKDL-02/03/04/visDIM PRO 30	90-305V	24V	4.0A	100W	100-0.1	IP67/IP20
	HLG-150H-24	KKDL-02/03/04/visDIM PRO 30	90-305V	24V	6.3A	150W	100-0.1	IP67/IP20
	HLG-240H-24	KKDL-02/03/04/visDIM PRO 30	90-305V	24V	10.0A	240W	100-0.1	IP67/IP20
DMX RGB	CEN-60-24	KKSC-05	90-295V	24V	2.5A	60W	100-0.9	IP67/IP20
	HLG-60H-24	KKSC-05	90-305V	24V	2.5A	60W	100-0.9	IP67/IP20
	HLG-100H-24	KKSC-05	90-305V	24V	4A	100W	100-0.9	IP67/IP20
	HLG-150H-24	KKSC-05	90-305V	24V	6.3A	150W	100-0.9	IP67/IP20
	HLG-240H-24	KKSC-05	90-305V	24V	10.0A	240W	100-0.9	IP67/IP20

¹ The items shown above cover the most frequently used specification but does not exhaust the possible options

² PSU and/or driver can be chosen from the table, or KKDC may recommend the best option upon receipt of the controls requirement and installation environment

³ Electrical shop drawing will include detailed information of PSU and relevant control drivers

⁴ Cut sheets are available on the controls section of www.kkdc.lighting or upon request